

Dell™ OptiPlex™ 320

Quick Reference Guide

Models DCSM, DCNE

www.dell.com | support.dell.com

Notes, Notices, and Cautions



NOTE: A NOTE indicates important information that helps you make better use of your computer.



NOTICE: A NOTICE indicates either potential damage to hardware or loss of data and tells you how to avoid the problem.



CAUTION: A CAUTION indicates a potential for property damage, personal injury, or death.

If you purchased a Dell™ n Series computer, any references in this document to Microsoft® Windows® operating systems are not applicable.

Information in this document is subject to change without notice.

© 2006 Dell Inc. All rights reserved.

Reproduction in any manner whatsoever without the written permission of Dell Inc. is strictly forbidden.

Trademarks used in this text: *Dell*, *OptiPlex*, and the *DELL* logo are trademarks of Dell Inc.; *Microsoft* and *Windows* are registered trademarks of Microsoft Corporation; *Intel* and *Pentium* are registered trademarks of Intel Corporation.

Other trademarks and trade names may be used in this document to refer to either the entities claiming the marks and names or their products. Dell Inc. disclaims any proprietary interest in trademarks and trade names other than its own.

Models DCSM, DCNE

September 2006

P/N JK523

Rev. A01



Contents

Finding Information	5
Setting Up Your Computer	8
System Views	11
Mini Tower Computer — Front View	11
Mini Tower Computer — Back View	13
Mini Tower Computer — Back-Panel Connectors	14
Desktop Computer — Front View.	16
Desktop Computer — Back View.	17
Desktop Computer — Back-Panel Connectors	18
Removing the Computer Cover.	19
Before You Begin	20
Mini Tower Computer.	21
Desktop Computer	23
Inside Your Computer	24
Mini Tower Computer.	24
Desktop Computer	27
Solving Problems	30
Dell Diagnostics.	30
System Lights	33
Diagnostic Lights.	34
Beep Codes	37
Resolving Software and Hardware Incompatibilities	38
Using Microsoft Windows XP System Restore.	38
Reinstalling Microsoft Windows XP	39
Using the Drivers and Utilities CD.	42
 Index.	 43

Finding Information

 **NOTE:** Some features or media may be optional and may not ship with your computer. Some features or media may not be available in certain countries.

 **NOTE:** Additional information may ship with your computer.

What Are You Looking For?	Find It Here
<ul style="list-style-type: none">• A diagnostic program for my computer• Drivers for my computer• My computer documentation• My device documentation• Desktop System Software (DSS)	<p>Drivers and Utilities CD (also known as ResourceCD)</p> <p>NOTE: The <i>Drivers and Utilities</i> CD may be optional and may not ship with your computer.</p> <p>Documentation and drivers are already installed on your computer. You can use the CD to reinstall drivers (see "Reinstalling Drivers and Utilities" in your online <i>User's Guide</i>), to run the Dell Diagnostics (see "Dell Diagnostics" on page 30), or to access your documentation.</p> <p>Readme files may be included on your CD to provide the most current updates about technical changes to your computer or advanced technical-reference material for technicians or experienced users.</p>  <p>NOTE: Drivers and documentation updates can be found at support.dell.com.</p>
<ul style="list-style-type: none">• Warranty information• Terms and Conditions (U.S. only)• Safety instructions• Regulatory information• Ergonomics information• End User License Agreement	<p>Dell™ Product Information Guide</p> 

What Are You Looking For?

- How to remove and replace parts
- Specifications
- How to configure system settings
- How to troubleshoot and solve problems

Find It Here

Dell™ OptiPlex™ User's Guide

Microsoft Windows XP Help and Support Center

- 1 Click Start→ Help and Support→ Dell User and System Guides→ System Guides.
- 2 Click the *User's Guide* for your computer.

The *User's Guide* is also available on the optional *Drivers and Utilities* CD.

-
- Service Tag and Express Service Code
 - Microsoft Windows License Label

Service Tag and Microsoft® Windows® License

These labels are located on your computer.

- Use the Service Tag to identify your computer when you use support.dell.com or contact support.
- Enter the Express Service Code to direct your call when contacting support.



-
- How to reinstall my operating system

Operating System CD

NOTE: The *Operating System* CD may be optional and may not ship with your computer.

The operating system is already installed on your computer. To reinstall your operating system, use the *Operating System* CD. See "Reinstalling Microsoft Windows XP" on page 39.



After you reinstall your operating system, you can use the optional *Drivers and Utilities* CD (*ResourceCD*) to reinstall drivers for the devices that came with your computer.

Your operating system product key label is located on your computer.

NOTE: The color of your CD varies based on the operating system you ordered.

What Are You Looking For?	Find It Here
<ul style="list-style-type: none"> • Solutions — Troubleshooting hints and tips, articles from technicians, frequently asked questions, and online courses • Community — Online discussion with other Dell customers • Upgrades — Upgrade information for components, such as memory, the hard drive, and the operating system • Customer Care — Contact information, service call and order status, warranty, and repair information • Service and support — Service call status and support history, service contract, online discussions with technical support • Reference — Computer documentation, details on my computer configuration, product specifications, and white papers • Downloads — Certified drivers, patches, and software updates • Desktop System Software (DSS) — If you reinstall the operating system for your computer, you should also reinstall the DSS utility. DSS provides critical updates for your operating system and support for Dell™ 3.5-inch USB floppy drives, Intel® processors, optical drives, and USB devices. DSS is necessary for correct operation of your Dell computer. The software automatically detects your computer and operating system and installs the updates appropriate for your configuration. 	<p>Dell Support Website — support.dell.com</p> <p>NOTE: Select your region or business segment to view the appropriate support site.</p> <p>To download Desktop System Software:</p> <ol style="list-style-type: none"> 1 Go to support.dell.com, select your region or business segment, and enter your Service Tag. 2 Select Drivers & Downloads and click Go. 3 Click your operating system and search for the keyword <i>Desktop System Software</i>. <p>NOTE: The support.dell.com user interface may vary dependent upon your selections.</p>
<ul style="list-style-type: none"> • How to use Windows XP • How to work with programs and files • How to personalize my desktop 	<p>Windows Help and Support Center</p> <ol style="list-style-type: none"> 1 Click Start→ Help and Support. 2 Type a word or phrase that describes your problem and click the arrow icon. 3 Click the topic that describes your problem. 4 Follow the instructions on the screen.

Setting Up Your Computer

⚠ CAUTION: Before performing any of the procedures in this section, follow the safety instructions in *Product Information Guide*.

➡ NOTICE: If your computer has an expansion card installed (such as a modem card), connect the appropriate cable to the card, *not* to the connector on the back panel.

➡ NOTICE: To help allow the computer to maintain proper operating temperature, ensure that you do not place the computer too close to a wall or other storage compartment that might prevent air circulation around the chassis.

📄 NOTE: Before you install any devices or software that did not ship with your computer, read the documentation that came with the device or software, or contact the vendor to verify that the device or software is compatible with your computer and operating system.

You must complete all the steps to properly set up your computer. See the appropriate figures that follow the instructions.

➡ NOTICE: Do not attempt to operate a PS/2 mouse and a USB mouse simultaneously.

1 Connect the keyboard and mouse.

➡ NOTICE: Do not connect a modem cable to the network adapter connector. Voltage from telephone communications can cause damage to the network adapter.

Set Up Your Keyboard and Mouse

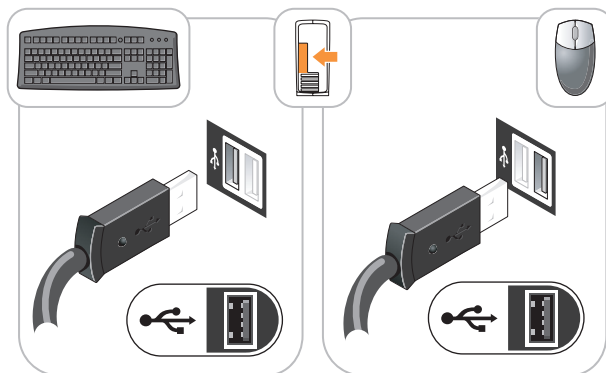

2 Connect the modem or network cable.

Insert the network cable, not the telephone line, into the network connector. If you have an optional modem, connect the telephone line to the modem.

- 3 Connect the monitor using *either* the white DVI cable *or* the blue VGA cable (*do not* connect both cables).

Align and gently insert the monitor cable to avoid bending connector pins. Tighten the thumbscrews on the cable connectors.

 **NOTE:** Some monitors have the video connector underneath the back of the screen. See the documentation that came with your monitor for its connector locations.

Set Up Your Monitor

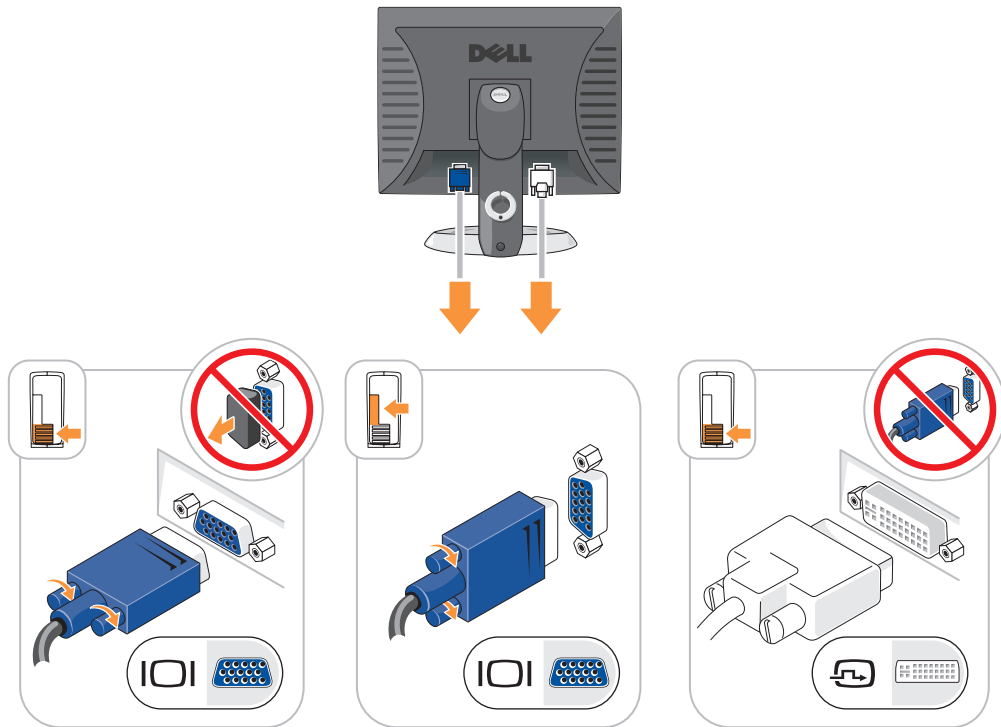

- 4 Connect the speakers.

- 5 Connect power cables to the computer, monitor, and devices and connect the other ends of the power cables to electrical outlets.

Power Connections

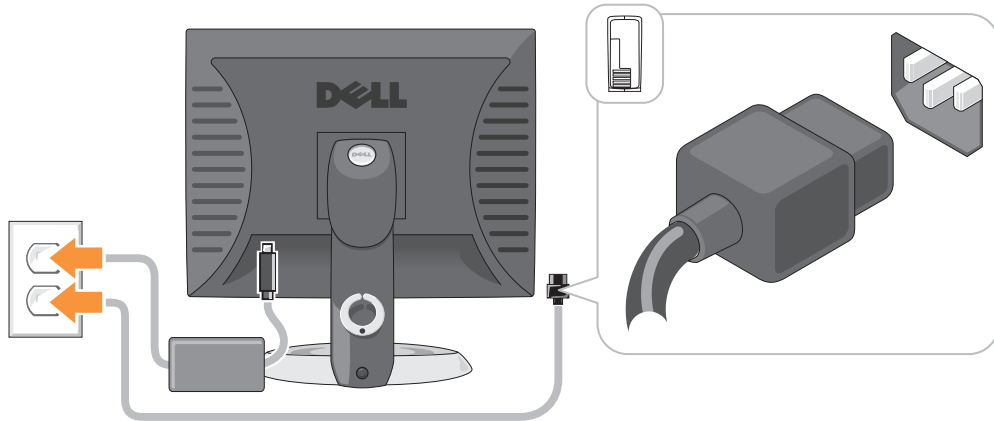

➔ **NOTICE:** To avoid damaging a computer with a manual voltage-selection switch, set the switch for the voltage that most closely matches the AC power available in your location.

➔ **NOTICE:** In Japan, the voltage selection switch must be set to the 115-V position even though the AC power available in Japan is 100 V.

- 6 Verify that the voltage selection switch is set correctly for your location.



Your computer has a manual voltage-selection switch. Computers with a voltage selection switch on the back panel must be manually set to operate at the correct operating voltage.

System Views

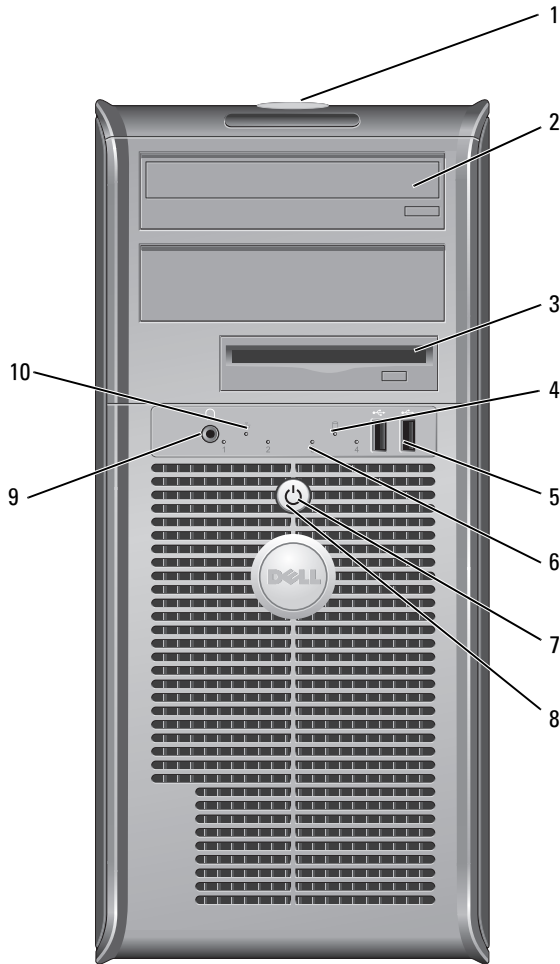
Mini Tower Computer — Front View



- | | | |
|---|---------------------------|---|
| 1 | location of Service Tag | Use the Service Tag to identify your computer when you access the Dell Support website or call technical support. |
| 2 | CD/DVD drive | Insert a CD or DVD (if supported) into this drive. |
| 3 | floppy drive | Insert a floppy disk into this drive. |
| 4 | hard-drive activity light | This light flickers when the hard drive is in use. |

- 5 USB 2.0 connectors (2) Use the USB connectors on the front of the computer for devices that you connect occasionally, such as joysticks or cameras, or for bootable USB devices.
It is recommended that you use the USB connectors on the back of the computer for devices that typically remain connected, such as printers and keyboards.
- 6 diagnostic lights Use the lights to help you troubleshoot a computer problem based on the diagnostic code (for more information, see "Diagnostic Lights" on page 34).
- 7 power button Press this button to turn on the computer.
 **NOTICE:** To avoid losing data, do not turn off the computer by pressing the power button. Instead, perform an operating system shutdown.
 **NOTICE:** If your operating system has ACPI enabled, when you press the power button the computer will perform an operating system shutdown.
- 8 power light The power light illuminates and blinks or remains solid to indicate different operating states:
 - No light — The computer is turned off.
 - Steady green — The computer is in a normal operating state.
 - Blinking green — The computer is in a power-saving mode.
 - Blinking or solid amber — The computer is receiving electrical power, but an internal power problem might exist. See "Power Problems" in your online *User's Guide*.

To exit from a power-saving mode, press the power button or use the keyboard or the mouse if it is configured as a wake device in the Windows Device Manager. For more information about sleep modes and exiting from a power-saving mode, see your online *User's Guide*.

For a description of light codes that can help you troubleshoot problems with your computer, see "System Lights" on page 33.
- 9 headphone connector Use the headphone connector to attach headphones.
- 10 link integrity light
 - Green — A good connection exists between a 10-Mbps network and the computer.
 - Orange — A good connection exists between a 100-Mbps network and the computer.
 - Off — The computer is not detecting a physical connection to the network.

Mini Tower Computer — Back View

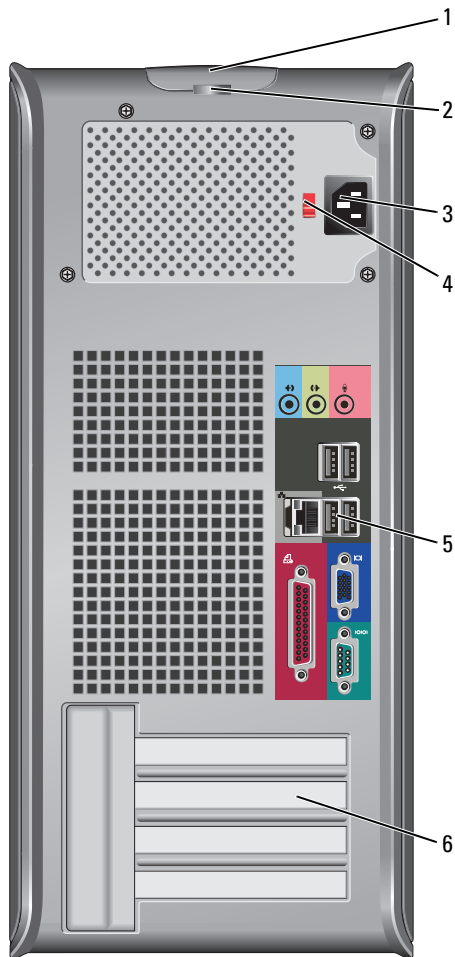

- | | | |
|---|---------------------|---|
| 1 | cover release latch | This latch allows you to open the computer cover. |
| 2 | padlock ring | Insert a padlock to lock the computer cover. |
| 3 | power connector | Insert the power cable into this connector. |

- 4 voltage selection switch Your computer is equipped with a manual voltage-selection switch. To avoid damaging a computer with a manual voltage-selection switch, set the switch for the voltage that most closely matches the AC power available in your location.

➔ NOTICE: In Japan the voltage-selection switch must be set to the 115-V position.

Also, ensure that your monitor and attached devices are electrically rated to operate with the AC power available in your location.

- 5 back-panel connectors Plug serial, USB, and other devices into the appropriate connector. See "Mini Tower Computer — Back-Panel Connectors" on page 14.
- 6 card slots Access connectors for any installed PCI and PCI Express cards.

Mini Tower Computer — Back-Panel Connectors

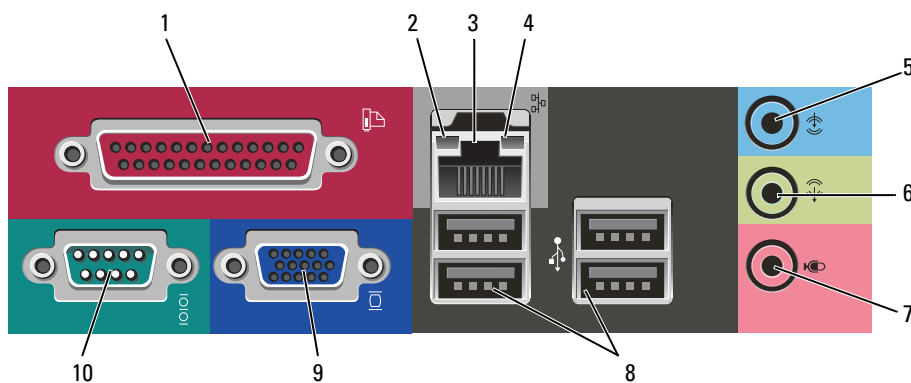

- 1 parallel connector Connect a parallel device, such as a printer, to the parallel connector. If you have a USB printer, plug it into a USB connector.

NOTE: The integrated parallel connector is automatically disabled if the computer detects an installed card containing a parallel connector configured to the same address. For more information, see your online *User's Guide*.

- 2 link integrity light
- Green — A good connection exists between a 10-Mbps network and the computer.
 - Orange — A good connection exists between a 100-Mbps network and the computer.
 - Off — The computer is not detecting a physical connection to the network.

- 3 network adapter connector To attach your computer to a network or broadband device, connect one end of a network cable to a network jack or your network or broadband device. Connect the other end of the network cable to the network adapter connector on the back panel of your computer. A click indicates that the network cable has been securely attached.
- NOTE:** Do not plug a telephone cable into the network connector.
- On computers with a network adapter card, use the connector on the card.
- It is recommended that you use Category 5 wiring and connectors for your network. If you must use Category 3 wiring, force the network speed to 10 Mbps to ensure reliable operation.
- 4 network activity light This light flashes yellow when the computer is transmitting or receiving network data. A high volume of network traffic may make this light appear to be in a steady "on" state.
- 5 line-in connector Use the blue line-in connector to attach a record/playback device such as a cassette player, CD player, or VCR.
- On computers with a sound card, use the connector on the card.
- 6 line-out connector Use the green line-out connector to attach headphones and most speakers with integrated amplifiers.
- On computers with a sound card, use the connector on the card.
- 7 microphone connector Use the pink microphone connector to attach a personal computer microphone for voice or musical input into a sound or telephony program.
- On computers with a sound card, the microphone connector is on the card.
- 8 USB 2.0 connectors (4) Use the back USB connectors for devices that typically remain connected, such as printers and keyboards.
- 9 video connector Plug the cable from your VGA-compatible monitor into the blue connector.
- NOTE:** If you purchased an optional graphics card, this connector will be covered by a cap. Connect your monitor to the connector on the graphics card. Do not remove the cap.
- 10 serial connector Connect a serial device, such as a handheld device, to the serial port. The default designation is COM1 for serial connector 1.
- For more information, see your online *User's Guide*.

Desktop Computer — Front View

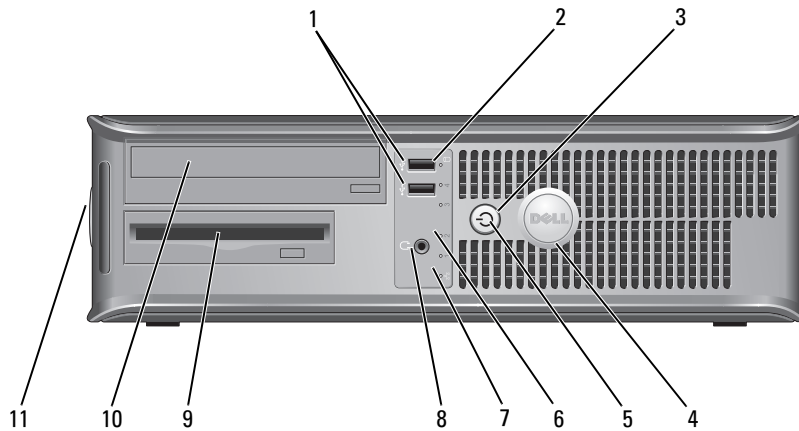

- 1 USB 2.0 connectors (2) Use the USB connectors on the front of the computer for devices that you connect occasionally, such as joysticks or cameras, or for bootable USB devices (see your online *User's Guide* for more information about booting to a USB device).
It is recommended that you use the USB connectors on the back panel for devices that typically remain connected, such as printers and keyboards.
- 2 hard-drive activity light This light flickers when the hard drive is being accessed.
- 3 power button Press this button to turn on the computer.
➡ NOTICE: To avoid losing data, do not turn off the computer by pressing the power button for 6 seconds or longer. Instead, perform an operating system shutdown.
➡ NOTICE: If your operating system has ACPI enabled, when you press the power button the computer will perform an operating system shutdown.
- 4 Dell badge This badge can be rotated to match the orientation of your computer. To rotate the badge, place your fingers around the outside of the badge, press firmly, and turn the badge. You can also rotate the badge using the slot provided near the bottom of the badge.

- | | | |
|----|-------------------------|--|
| 5 | power light | <p>The power light illuminates and blinks or remains solid to indicate different operating states:</p> <ul style="list-style-type: none"> • No light — The computer is turned off. • Steady green — The computer is in a normal operating state. • Blinking green — The computer is in a power-saving mode. • Blinking or solid amber — See "Power Problems" in your online <i>User's Guide</i>. <p>To exit from a power-saving mode, press the power button or use the keyboard or the mouse if it is configured as a wake device in the Windows Device Manager.</p> <p>For a description of light codes that can help you troubleshoot problems with your computer see "System Lights" on page 33.</p> |
| 6 | diagnostic lights | <p>Use the lights to help you troubleshoot a computer problem based on the diagnostic code. For more information, see "Diagnostic Lights" on page 34.</p> |
| 7 | link integrity light | <ul style="list-style-type: none"> • Green — A good connection exists between a 10-Mbps network and the computer. • Orange — A good connection exists between a 100-Mbps network and the computer. • Off — The computer is not detecting a physical connection to the network. |
| 8 | headphone connector | Use the headphone connector to attach headphones. |
| 9 | floppy drive | Insert a floppy disk into this drive. |
| 10 | CD/DVD drive | Insert a CD or DVD (if supported) into this drive. |
| 11 | location of Service Tag | Use the Service Tag to identify your computer when you access the Dell Support website or call technical support. |

Desktop Computer — Back View

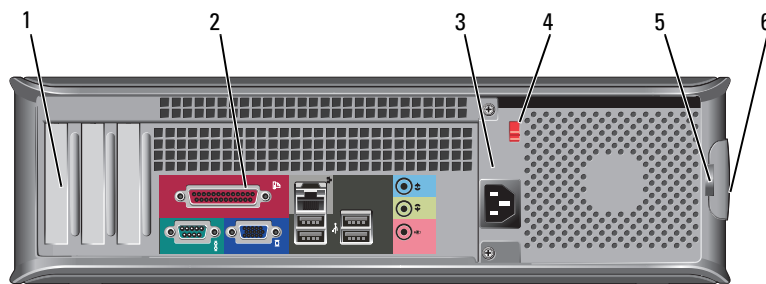

- | | | |
|---|-----------------------|--|
| 1 | card slots | Access connectors for any installed PCI and PCI Express Cards. |
| 2 | back-panel connectors | Plug serial, USB, and other devices into the appropriate connector. See "Desktop Computer — Back-Panel Connectors" on page 18. |
| 3 | power connector | Insert the power cable into this connector. |

- 4 voltage selection switch Your computer is equipped with a manual voltage-selection switch. To avoid damaging a computer with a manual voltage-selection switch, set the switch for the voltage that most closely matches the AC power available in your location.

➡ NOTICE: In Japan, the voltage-selection switch must be set to the 115-V position.

Also, ensure that your monitor and attached devices are electrically rated to operate with the AC power available in your location.

- 5 padlock ring Insert a padlock to lock the computer cover.
 6 cover release latch Use this latch to open the computer cover.

Desktop Computer — Back-Panel Connectors

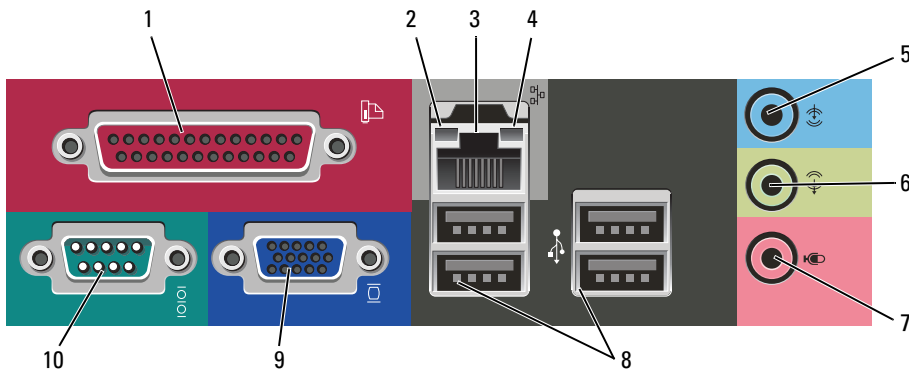

- 1 parallel connector Connect a parallel device, such as a printer, to the parallel connector. If you have a USB printer, plug it into a USB connector.
NOTE: The integrated parallel connector is automatically disabled if the computer detects an installed card containing a parallel connector configured to the same address. For more information, see your online *User's Guide*.
- 2 link integrity light
- Green — A good connection exists between a 10-Mbps network and the computer.
 - Orange — A good connection exists between a 100-Mbps network and the computer.
 - Off — The computer is not detecting a physical connection to the network.

- | | | |
|----|---------------------------|---|
| 3 | network adapter connector | <p>To attach your computer to a network or broadband device, connect one end of a network cable to either a network jack or your network or broadband device. Connect the other end of the network cable to the network adapter connector on the back panel of your computer. A click indicates that the network cable has been securely attached.</p> <p>NOTE: Do not plug a telephone cable into the network connector.</p> <p>On computers with a network adapter card, use the connector on the card.</p> <p>It is recommended that you use Category 5 wiring and connectors for your network. If you must use Category 3 wiring, force the network speed to 10 Mbps to ensure reliable operation.</p> |
| 4 | network activity light | <p>This light flashes yellow when the computer is transmitting or receiving network data. A high volume of network traffic may make this light appear to be in a steady "on" state.</p> |
| 5 | line-in connector | <p>Use the blue line-in connector to attach a record/playback device such as a cassette player, CD player, or VCR.</p> <p>On computers with a sound card, use the connector on the card.</p> |
| 6 | line-out connector | <p>Use the green line-out connector to attach headphones and most speakers with integrated amplifiers.</p> <p>On computers with a sound card, use the connector on the card.</p> |
| 7 | microphone connector | <p>Use the pink microphone connector to attach a personal computer microphone for voice or musical input into a sound or telephony program.</p> <p>On computers with a sound card, the microphone connector is on the card.</p> |
| 8 | USB 2.0 connectors (4) | <p>Use the back USB connectors for devices that typically remain connected, such as printers and keyboards.</p> |
| 9 | video connector | <p>Plug the cable from your VGA-compatible monitor into the blue connector.</p> <p>NOTE: If you purchased an optional graphics card, this connector will be covered by a cap. Connect your monitor to the connector on the graphics card. Do not remove the cap.</p> |
| 10 | serial connector | <p>Connect a serial device, such as a handheld device, to the serial port. The default designation is COM1 for serial connector 1.</p> <p>For more information, see your online <i>User's Guide</i>.</p> |

Removing the Computer Cover

 **CAUTION:** Before you begin any of the procedures in this section, follow the safety instructions in the *Product Information Guide*.

 **CAUTION:** To guard against electrical shock, always unplug your computer from the electrical outlet before removing the cover.

Before You Begin

 **NOTICE:** To avoid losing data, save and close any open files and exit any open programs before you turn off your computer.

- 1 Shut down the operating system:
 - a Save and close any open files, exit any open programs, click the **Start** button, and then click **Turn Off Computer**.
 - b In the **Turn off computer** window, click **Turn off**.
The computer turns off after the operating system shutdown process finishes.
- 2 Ensure that the computer and any attached devices are turned off. If your computer and attached devices did not automatically turn off when you shut down your operating system, turn them off now.

Before Working Inside Your Computer

Use the following safety guidelines to help protect your computer from potential damage and to help ensure your own personal safety.

 **CAUTION:** Before you begin any of the procedures in this section, follow the safety instructions in the *Product Information Guide*.

 **CAUTION:** Handle components and cards with care. Do not touch the components or contacts on a card. Hold a card by its edges or by its metal mounting bracket. Hold a component such as a processor by its edges, not by its pins.

 **NOTICE:** Only a certified service technician should perform repairs on your computer. Damage due to servicing that is not authorized by Dell is not covered by your warranty.

 **NOTICE:** When you disconnect a cable, pull on its connector or on its strain-relief loop, not on the cable itself. Some cables have a connector with locking tabs; if you are disconnecting this type of cable, press in on the locking tabs before you disconnect the cable. As you pull connectors apart, keep them evenly aligned to avoid bending any connector pins. Also, before you connect a cable, ensure that both connectors are correctly oriented and aligned.

To avoid damaging the computer, perform the following steps before you begin working inside the computer.

- 1 Turn off your computer.

 **NOTICE:** To disconnect a network cable, first unplug the cable from your computer and then unplug it from the network wall jack.

- 2 Disconnect any telephone or telecommunication lines from the computer.
- 3 Disconnect your computer and all attached devices from their electrical outlets, and then press the power button to ground the system board.
- 4 If applicable, remove the computer stand (for instructions, see the documentation that came with the stand).

 **CAUTION:** To guard against electrical shock, always unplug your computer from the electrical outlet before removing the cover.

5 Remove the computer cover:

- Remove the mini tower computer cover (see "Mini Tower Computer" on page 21).
- Remove the desktop computer cover (see "Desktop Computer" on page 27).



NOTICE: Before touching anything inside your computer, ground yourself by touching an unpainted metal surface, such as the metal at the back of the computer. While you work, periodically touch an unpainted metal surface to dissipate any static electricity that could harm internal components.

Mini Tower Computer



CAUTION: Before you begin any of the procedures in this section, follow the safety instructions in the *Product Information Guide*.



CAUTION: To guard against electrical shock, always unplug your computer from the electrical outlet before removing the computer cover.

- 1 Follow the procedures in "Before You Begin" on page 19.
- 2 If you have installed a padlock through the padlock ring on the back panel, remove the padlock.
- 3 Lay the computer on its side.
- 4 Slide the cover release latch back as you lift the cover.
- 5 Grip the sides of the computer cover and pivot the cover up using the hinge tabs as leverage points.
- 6 Remove the cover from the hinge tabs and set it aside on a soft nonabrasive surface.

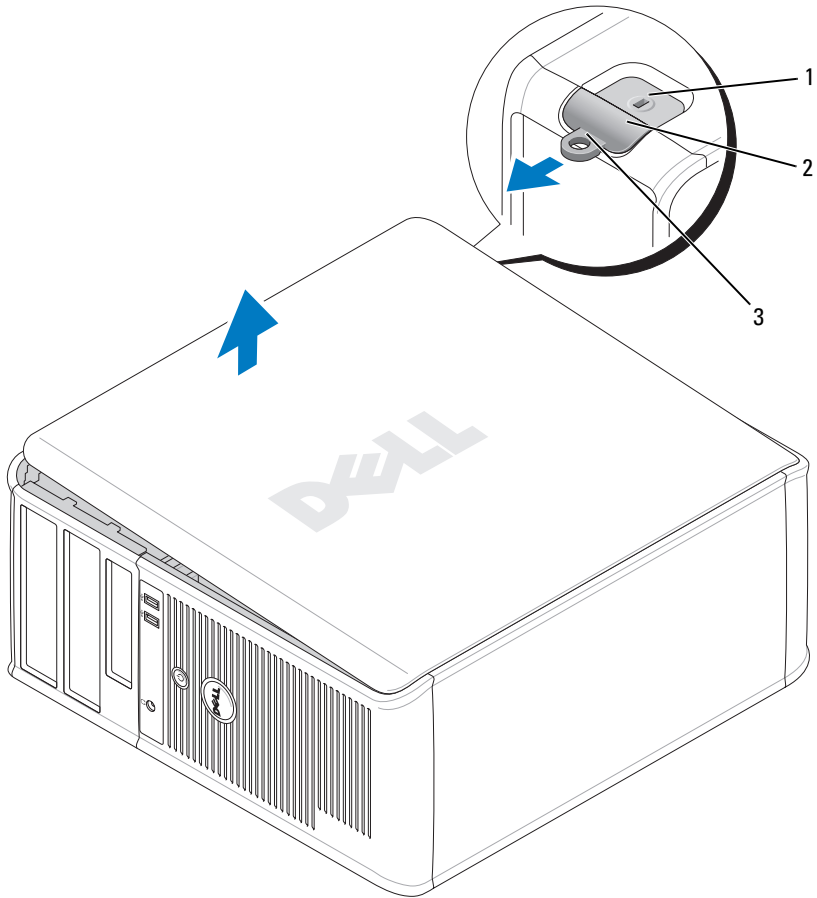

-
- 1 security cable slot
 - 2 cover release latch
 - 3 padlock ring
-

Desktop Computer

⚠ CAUTION: Before you begin any of the procedures in this section, follow the safety instructions in the *Product Information Guide*.

⚠ CAUTION: To guard against electrical shock, always unplug your computer from the electrical outlet before removing the computer cover.

- 1 Follow the procedures in "Before You Begin" on page 19.
- 2 If you have installed a padlock through the padlock ring on the back panel, remove the padlock.
- 3 Slide the cover release latch back as you lift the cover.
- 4 Pivot the cover up using the hinge tabs as leverage points.
- 5 Remove the cover from the hinge tabs and set it aside on a soft nonabrasive surface.

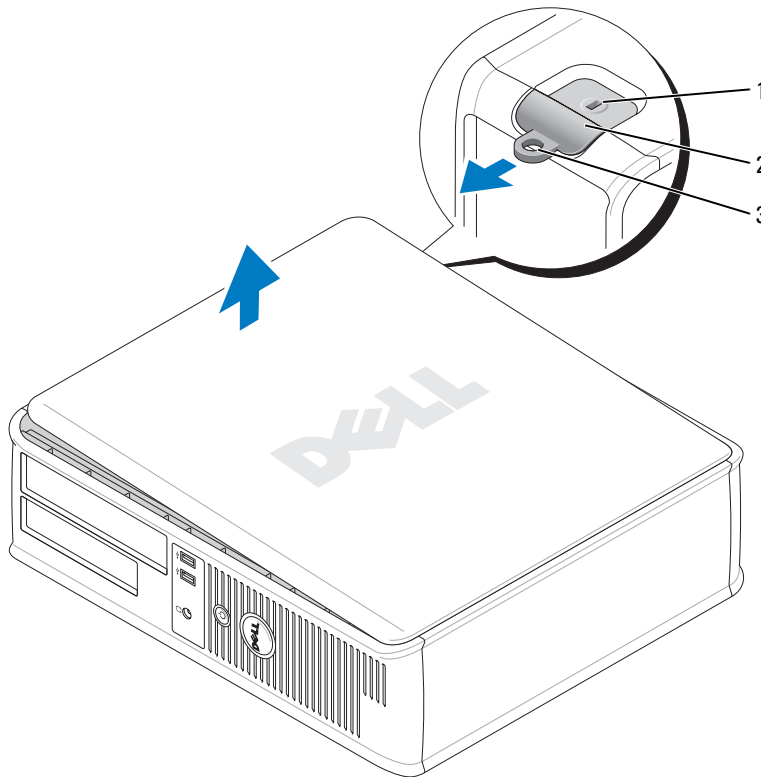

1 security cable slot

2 cover release latch

3 padlock ring

Inside Your Computer

Mini Tower Computer

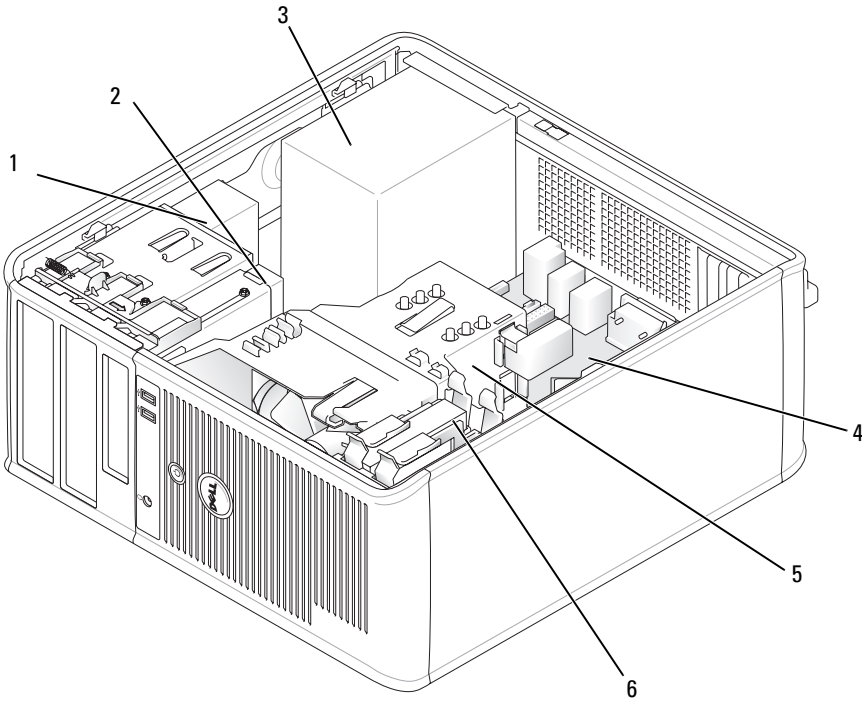

1	CD/DVD drive	4	system board
2	floppy drive	5	heat sink assembly
3	power supply	6	hard drive

System Board Components

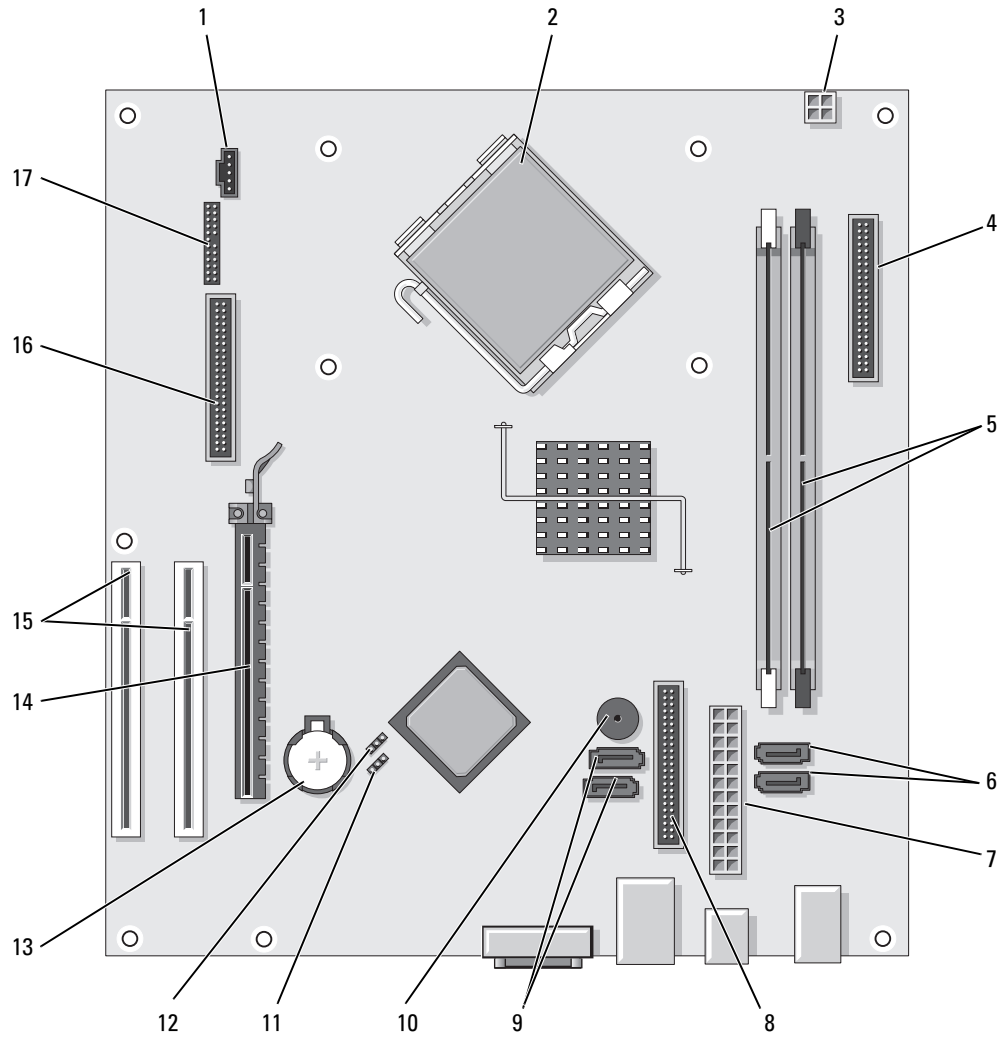



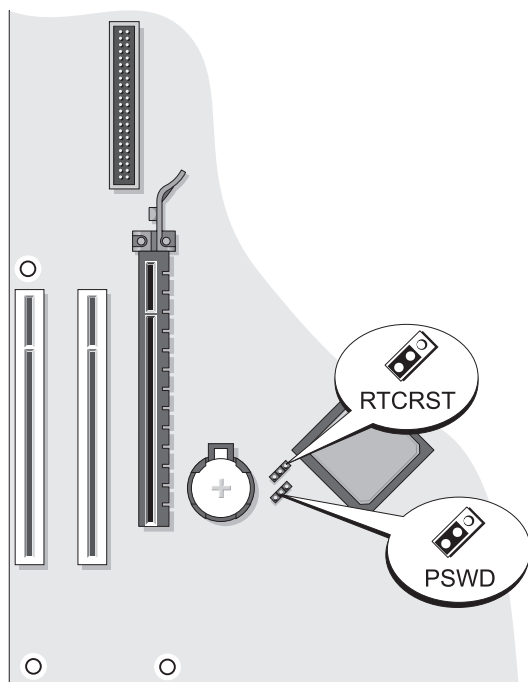

1	fan connector (FAN)	10	internal buzzer (SPKR1)
2	processor connector (CPU)	11	password jumper (PSWD)
3	processor power connector (12VPOWER)	12	real time clock reset jumper (RTCRST)
4	front-panel connector (FNT_PANEL)	13	battery socket (BATT)
5	memory module connectors (DIMM_1, DIMM_2)	14	PCI Express x16 card connector
6	SATA drive connectors (SATA0, SATA1)	15	PCI card connectors (2)
7	power connector (POWER)	16	floppy drive connector (FLOPPY)
8	CD/DVD drive connector (IDE)	17	serial/ PS/2 connector (PS2/SER2)
9	SATA drive connectors (SATA2, SATA3)		

Jumper Settings

Mini Tower Computer



Jumper	Setting	Description
PSWD	 1	Password features are enabled (default setting).
		Password features are disabled.
RTCST	 1	The real-time clock has been enabled (default setting).
		The real-time clock is being reset (jumpered temporarily).

 *jumpered*  *unjumpered*

Desktop Computer

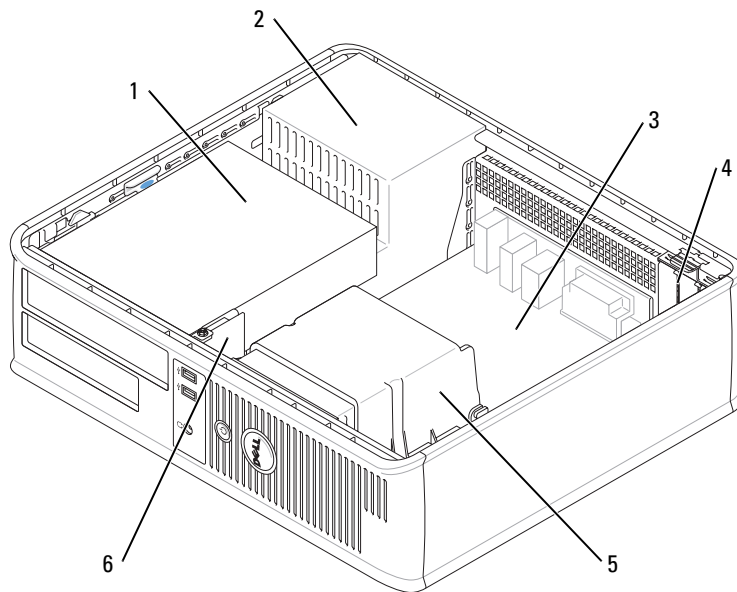

1	drive bay (CD/DVD, floppy, and hard drive)	4	card slots
2	power supply	5	heat sink assembly
3	system board	6	front I/O panel

System Board Components

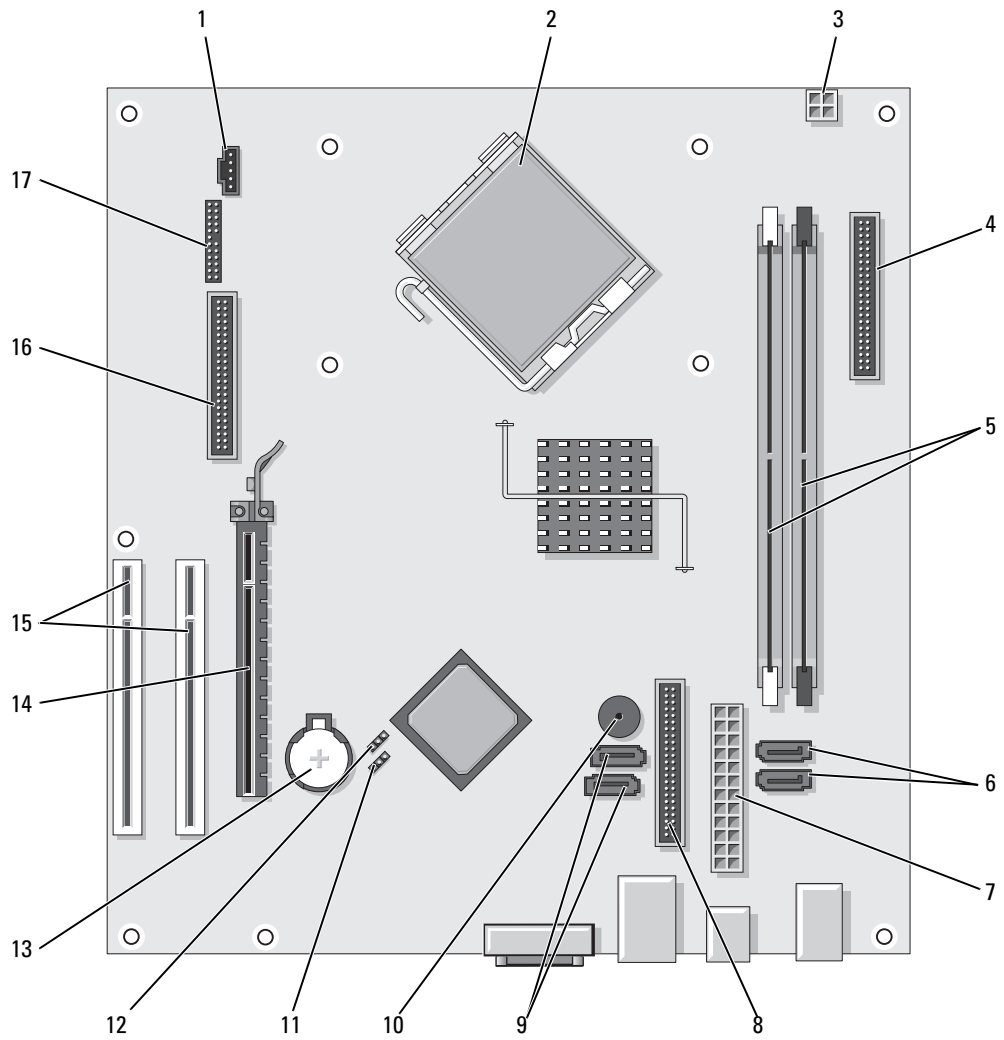



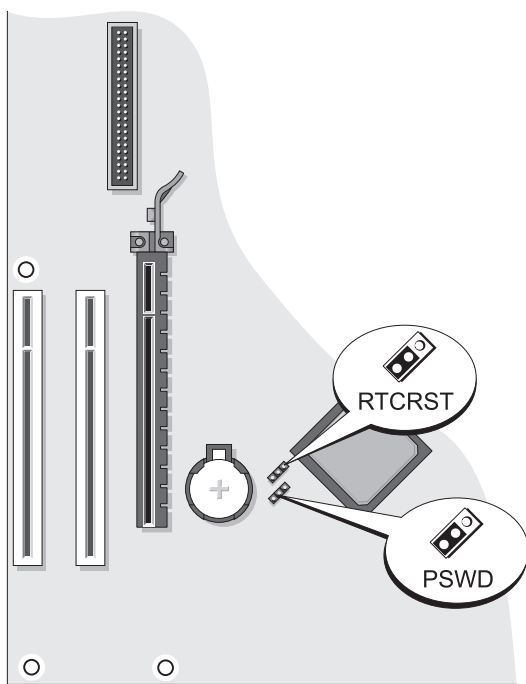

1	fan connector (FAN)	10	internal buzzer (SPKR1)
2	processor connector (CPU)	11	password jumper (PSWD)
3	processor power connector (12VPOWER)	12	RTC reset jumper (RTCRST)
4	front-panel connector (FNT_PANEL)	13	battery socket (BATT)
5	memory module connectors (DIMM_1, DIMM_2)	14	PCI Express x16 card connector
6	serial ATA drive connectors (SATA0, SATA1)	15	PCI card connector (2)
7	power connector (POWER)	16	floppy drive connector (FLOPPY)
8	CD/DVD drive connector (IDE)	17	serial/ PS/2 connector (PS2/SER2)
9	serial ATA drive connectors (SATA2, SATA3)		

Jumper Settings

Desktop Computer



Jumper	Setting	Description
PSWD	 1	Password features are enabled (default setting).
		Password features are disabled.
RTCRST	 1	The real-time clock has been enabled (default setting).
		The real-time clock is being reset (jumpered temporarily).

 *jumpered*  *unjumpered*

Solving Problems

Dell provides a number of tools to help you if your computer does not perform as expected. For the latest troubleshooting information available for your computer, see the Dell Support website at support.dell.com.

If computer problems occur that require help from Dell, write a detailed description of the error, beep codes, or diagnostics light patterns, record your Express Service Code and Service Tag below, and then contact Dell from the same location as your computer. For information on contacting Dell, see your online *User's Guide*.

For an example of the Express Service Code and Service Tag, see "Finding Information" on page 5.

Express Service Code: _____

Service Tag: _____

Dell Diagnostics

 **CAUTION:** Before you begin any of the procedures in this section, follow the safety instructions in the *Product Information Guide*.

When to Use the Dell Diagnostics

If you experience a problem with your computer, perform the checks in "Solving Problems" in your online *User's Guide* and run the Dell Diagnostics before you contact Dell for technical assistance. For information on contacting Dell, see your online *User's Guide*.

 **NOTICE:** The Dell Diagnostics works only on Dell™ computers.

Enter system setup (see "System Setup" in your online *User's Guide* for instructions), review your computer's configuration information, and ensure that the device you want to test displays in system setup and is active.

Start the Dell Diagnostics from either your hard drive or from the optional *Drivers and Utilities* CD (also known as the ResourceCD).

Starting the Dell Diagnostics From Your Hard Drive

- 1 Turn on (or restart) your computer.
- 2 When the DELL logo appears, press <F12> immediately.

 **NOTE:** If you see a message stating that no diagnostics utility partition has been found, run the Dell Diagnostics from the optional *Drivers and Utilities* CD (see "Starting the Dell Diagnostics From the Drivers and Utilities CD" on page 31).

If you wait too long and the operating system logo appears, continue to wait until you see the Microsoft® Windows® desktop. Then shut down your computer and try again.

- 3 When the boot device list appears, highlight **Boot to Utility Partition** and press <Enter>.
- 4 When the Dell Diagnostics **Main Menu** appears, select the test you want to run.

Starting the Dell Diagnostics From the Drivers and Utilities CD

- 1 Insert the *Drivers and Utilities* CD.
- 2 Shut down and restart the computer.
When the DELL logo appears, press <F12> immediately.

If you wait too long and the operating system logo appears, continue to wait until you see the Microsoft Windows desktop. Then shut down your computer and try again.

 **NOTE:** The next steps change the boot sequence for one time only. On the next start-up, the computer boots according to the devices specified in system setup.

- 3 When the boot device list appears, highlight the listing for the CD/DVD drive and press <Enter>.
- 4 Select the listing for the CD/DVD drive option from the CD boot menu.
- 5 Select the option to boot from the CD/DVD drive from the menu that appears.
- 6 Type 1 to start the *Drivers and Utilities* CD menu.
- 7 Type 2 to start the Dell Diagnostics.
- 8 Select **Run the 32 Bit Dell Diagnostics** from the numbered list. If multiple versions are listed, select the version appropriate for your computer.
- 9 When the Dell Diagnostics **Main Menu** appears, select the test you want to run.

Dell Diagnostics Main Menu

- 1 After the Dell Diagnostics loads and the **Main Menu** screen appears, click the button for the option you want.

Option	Function
Express Test	Performs a quick test of devices. This test typically takes 10 to 20 minutes and requires no interaction on your part. Run Express Test first to increase the possibility of tracing the problem quickly.
Extended Test	Performs a thorough check of devices. This test typically takes an hour or more and requires you to answer questions periodically.
Custom Test	Tests a specific device. You can customize the tests you want to run.
Symptom Tree	Lists the most common symptoms encountered and allows you to select a test based on the symptom of the problem you are having.

- 2 If a problem is encountered during a test, a message appears with an error code and a description of the problem. Write down the error code and problem description and follow the instructions on the screen.

If you cannot resolve the error condition, contact Dell. For information on contacting Dell, see your online *User's Guide*.

 **NOTE:** The Service Tag for your computer is located at the top of each test screen. If you contact Dell, technical support will ask for your Service Tag.

- 3 If you run a test from the **Custom Test** or **Symptom Tree** option, click the applicable tab described in the following table for more information.

Tab	Function
Results	Displays the results of the test and any error conditions encountered.
Errors	Displays error conditions encountered, error codes, and the problem description.
Help	Describes the test and may indicate requirements for running the test.
Configuration	Displays your hardware configuration for the selected device. The Dell Diagnostics obtains configuration information for all devices from system setup, memory, and various internal tests, and it displays the information in the device list in the left pane of the screen. The device list may not display the names of all the components installed on your computer or all devices attached to your computer.
Parameters	You can customize the test by changing the test settings.

- 4 When the tests are completed, if you are running the Dell Diagnostics from the *Drivers and Utilities* CD (optional), remove the CD.

- 5 Close the test screen to return to the **Main Menu** screen. To exit the Dell Diagnostics and restart the computer, close the **Main Menu** screen.

System Lights

Your power light may indicate a computer problem.

Power Light	Problem Description	Suggested Resolution
Solid green	Power is on, and the computer is operating normally.	No corrective action is required.
Blinking green	The computer is in a power-saving mode.	Press the power button, move the mouse, or press a key on the keyboard to wake the computer.
Blinks green several times and then turns off	A configuration error exists.	Check Diagnostic Lights to see if the specific problem is identified (see "Diagnostic Lights" on page 34).
Solid yellow	The Dell Diagnostics is running a test, or a device on the system board may be faulty or incorrectly installed.	If the Dell Diagnostics is running, allow the testing to complete. Check Diagnostic Lights to see if the specific problem is identified (see "Diagnostic Lights" on page 34). If the computer does not boot, contact Dell for technical assistance. For information on contacting Dell, see your online <i>User's Guide</i> .
Blinking yellow	A power supply or system board failure has occurred.	Check Diagnostic Lights to see if the specific problem is identified (see "Diagnostic Lights" on page 34). See "Power Problems" in your online <i>User's Guide</i> .
Solid green and a beep code during POST	A problem was detected while the BIOS was executing.	For instructions on diagnosing the beep code see "Beep Codes" on page 37. Also, check Diagnostic Lights to see if the specific problem is identified.
Solid green power light, no beep code and no video during POST	The monitor or the graphics card may be faulty or incorrectly installed.	Check Diagnostic Lights to see if the specific problem is identified.
Solid green power light and no beep code, but the computer locks up during POST	An integrated system board device may be faulty.	Check Diagnostic Lights to see if the specific problem is identified. If the problem is not identified, contact Dell for technical assistance. For information on contacting Dell, see your online <i>User's Guide</i> .



Diagnostic Lights





 **CAUTION:** Before you begin any of the procedures in this section, follow the safety instructions in the *Product Information Guide*.





To help you troubleshoot a problem, your computer has four lights labeled "1," "2," "3," and "4" on the front or back panel. The lights can be "off" or green. When the computer starts normally, the patterns or codes on the lights change as the boot process completes. If the POST portion of system boot completes successfully, all four lights display solid green for a short time, and then turn off.

If the computer malfunctions during the POST process, the pattern displayed on the LEDs may help identify where in the process the computer halted. If the computer malfunctions after a successful POST, the diagnostic lights do not indicate the cause of the problem.

 **NOTE:** The orientation of the diagnostic lights may vary depending on the system type. The diagnostic lights can be either vertically or horizontally oriented.

Light Pattern	Problem Description	Suggested Resolution
	The computer is in a normal "off" condition, or a possible pre-BIOS failure has occurred. The diagnostic lights are not lit after the computer successfully boots to the operating system.	Plug the computer into a working electrical outlet and press the power button.
	A possible BIOS failure has occurred; the computer is in recovery mode.	Run the BIOS Recovery utility, wait for recovery completion, and then restart the computer.
	A possible processor failure has occurred.	Reinstall the processor and restart the computer. For information on reinstalling the processor, see your online <i>User's Guide</i> .

Light Pattern	Problem Description	Suggested Resolution
	Memory modules are detected, but a memory failure has occurred.	<ul style="list-style-type: none"> • If you have one memory module installed, reinstall it and restart the computer. For information on reinstalling memory modules, see your online <i>User's Guide</i>. • If you have two or more memory modules installed, remove the modules, reinstall one module, and then restart the computer. If the computer starts normally, reinstall an additional module. Continue until you have identified a faulty module or reinstalled all modules without error. • If available, install properly working memory of the same type into your computer. • If the problem persists, contact Dell. For information on contacting Dell, see your online <i>User's Guide</i>.
	A possible graphics card failure has occurred.	<ul style="list-style-type: none"> • If the computer has a graphics card, remove the card, reinstall it, and then restart the computer. • If the problem still exists, install a graphics card that you know works and restart the computer. • If the problem persists or the computer has integrated graphics, contact Dell. For information on contacting Dell, see your online <i>User's Guide</i>.
	A possible floppy or hard drive failure has occurred.	Reseat all power and data cables and restart the computer.
	A possible USB failure has occurred.	Reinstall all USB devices, check cable connections, and then restart the computer.

Light Pattern	Problem Description	Suggested Resolution
	No memory modules are detected.	<ul style="list-style-type: none"> • If you have one memory module installed, reinstall it and restart the computer. For information on reinstalling memory modules, see your online <i>User's Guide</i>. • If you have two or more memory modules installed, remove the modules, reinstall one module, and then restart the computer. If the computer starts normally, reinstall an additional module. Continue until you have identified a faulty module or reinstalled all modules without error. • If available, install properly working memory of the same type into your computer. • If the problem persists, contact Dell. For information on contacting Dell, see your online <i>User's Guide</i>.
	Memory modules are detected, but a memory configuration or compatibility error exists.	<ul style="list-style-type: none"> • Ensure that no special memory module/memory connector placement requirements exist. • Verify that the memory modules that you are installing are compatible with your computer. • If the problem persists, contact Dell. For information on contacting Dell, see your online <i>User's Guide</i>.
	A failure has occurred. This pattern also displays when you enter system setup and may not indicate a problem.	<ul style="list-style-type: none"> • Ensure that the cables are properly connected to the system board from the hard drive, CD drive, and DVD drive. • Check the computer message that appears on your monitor screen. • If the problem persists, contact Dell. For information on contacting Dell, see your online <i>User's Guide</i>.
	After POST is complete, all four diagnostic lights turn green briefly before turning off to indicate a normal operating condition.	None.

Beep Codes

Your computer might emit a series of beeps during start-up if the monitor cannot display errors or problems. This series of beeps, called a beep code, identifies a problem. One possible beep code (code 1-3-1) consists of one beep, a burst of three beeps, and then one beep. This beep code tells you that the computer encountered a memory problem.

If your computer beeps during start-up:

- 1 Write down the beep code.
- 2 See "Dell Diagnostics" on page 30 to identify a more serious cause.
- 3 Contact Dell for technical assistance. For information on contacting Dell, see your online *User's Guide*.

Code	Cause	Code	Cause
1-1-2	Microprocessor register failure	3-1-4	Slave interrupt mask register failure
1-1-3	NVRAM read/write failure	3-2-2	Interrupt vector loading failure
1-1-4	ROM BIOS checksum failure	3-2-4	Keyboard Controller test failure
1-2-1	Programmable interval timer failure	3-3-1	NVRAM power loss
1-2-2	DMA initialization failure	3-3-2	Invalid NVRAM configuration
1-2-3	DMA page register read/write failure	3-3-4	Video Memory test failure
1-3	Video Memory test failure	3-4-1	Screen initialization failure
1-3-1 through 2-4-4	Memory not being properly identified or used	3-4-2	Screen retrace failure
3-1-1	Slave DMA register failure	3-4-3	Search for video ROM failure
3-1-2	Master DMA register failure	4-2-1	No timer tick
3-1-3	Master interrupt mask register failure	4-2-2	Shutdown failure
4-2-3	Gate A20 failure	4-4-1	Serial or parallel port test failure
4-2-4	Unexpected interrupt in protected mode	4-4-2	Failure to decompress code to shadowed memory
4-3-1	Memory failure above address 0FFFFh	4-4-3	Math-coprocessor test failure
4-3-3	Timer-chip counter 2 failure	4-4-4	Cache test failure
4-3-4	Time-of-day clock stopped		

Resolving Software and Hardware Incompatibilities

If a device is either not detected during the operating system setup or is detected but incorrectly configured, you can use the Hardware Troubleshooter to resolve the incompatibility.

- 1 Click the **Start** button and click **Help and Support**.
- 2 Type `hardware troubleshooter` in the **Search** field and click the arrow to start the search.
- 3 Click **Hardware Troubleshooter** in the **Search Results** list.
- 4 In the **Hardware Troubleshooter** list, click **I need to resolve a hardware conflict on my computer**, and click **Next**.

Using Microsoft Windows XP System Restore

The Microsoft Windows XP operating system provides System Restore to allow you to return your computer to an earlier operating state (without affecting data files) if changes to the hardware, software, or other system settings have left the computer in an undesirable operating state. See the Windows Help and Support Center for information on using System Restore. To access the Windows Help and Support Center, see "Windows Help and Support Center" on page 7.

 **NOTICE:** Make regular backups of your data files. System Restore does not monitor your data files or recover them.

Creating a Restore Point

- 1 Click the **Start** button and click **Help and Support**.
- 2 Click **System Restore**.
- 3 Follow the instructions on the screen.

Restoring the Computer to an Earlier Operating State

 **NOTICE:** Before you restore the computer to an earlier operating state, save and close any open files and exit any open programs. Do not alter, open, or delete any files or programs until the system restoration is complete.

- 1 Click the **Start** button, point to **All Programs**→**Accessories**→**System Tools**, and then click **System Restore**.
- 2 Ensure that **Restore my computer to an earlier time** is selected, and click **Next**.
- 3 Click a calendar date to which you want to restore your computer.

The **Select a Restore Point** screen provides a calendar that allows you to see and select restore points. All calendar dates with available restore points appear in boldface type.

- 4 Select a restore point and click **Next**.

If a calendar date has only one restore point, then that restore point is automatically selected. If two or more restore points are available, click the restore point that you prefer.

- 5 Click **Next**.

The **Restoration Complete** screen appears after System Restore finishes collecting data and then the computer restarts.

- 6 After the computer restarts, click **OK**.

To change the restore point, you can either repeat the steps using a different restore point, or you can undo the restoration.

Undoing the Last System Restore



NOTICE: Before you undo the last system restore, save and close all open files and exit any open programs. Do not alter, open, or delete any files or programs until the system restoration is complete.

- 1 Click the **Start** button, point to **All Programs**→**Accessories**→**System Tools**, and then click **System Restore**.
- 2 Click **Undo my last restoration** and click **Next**.
- 3 Click **Next**.

The **System Restore** screen appears and the computer restarts.

- 4 After the computer restarts, click **OK**.

Enabling System Restore

If you reinstall Windows XP with less than 200 MB of free hard-disk space available, System Restore is automatically disabled. To verify that System Restore is enabled:

- 1 Click the **Start** button and click **Control Panel**.
- 2 Click **Performance and Maintenance**.
- 3 Click **System**.
- 4 Click the **System Restore** tab.
- 5 Ensure that **Turn off System Restore** is unchecked.

Reinstalling Microsoft Windows XP

Before You Begin



NOTE: The procedures in this document were written for the Windows default view in Windows XP Home Edition, so the steps will differ if you set your Dell computer to the Windows Classic view or are using Windows XP Professional.

If you are considering reinstalling the Windows XP operating system to correct a problem with a newly installed driver, first try using Windows XP Device Driver Rollback.



- 1 Click the **Start** button and click **Control Panel**.
- 2 Under **Pick a Category**, click **Performance and Maintenance**.

- 3 Click **System**.
- 4 In the **System Properties** window, click the **Hardware** tab.
- 5 Click **Device Manager**.
- 6 Right-click the device for which the new driver was installed and click **Properties**.
- 7 Click the **Drivers** tab.
- 8 Click **Roll Back Driver**.

If Device Driver Rollback does not resolve the problem, then use System Restore to return your operating system to the operating state it was in before you installed the new device driver (see "Using Microsoft Windows XP System Restore" on page 38).

 **NOTE:** The *Drivers and Utilities* CD contains drivers that were installed during assembly of the computer. Use the *Drivers and Utilities* CD to load any required drivers, including the drivers required if your computer has a RAID controller.

Reinstalling Windows XP



-  **NOTICE:** You must use Windows XP Service Pack 1 or later when you reinstall Windows XP.
-  **NOTICE:** Before performing the installation, back up all data files on your primary hard drive. For conventional hard drive configurations, the primary hard drive is the first drive detected by the computer.

To reinstall Windows XP, you need the following items:

- Dell *Operating System* CD
- Dell *Drivers and Utilities* CD

To reinstall Windows XP, perform all the steps in the following sections in the order in which they are listed.

The reinstallation process can take 1 to 2 hours to complete. After you reinstall the operating system, you must also reinstall the device drivers, virus protection program, and other software.

-  **NOTICE:** The *Operating System* CD provides options for reinstalling Windows XP. The options can overwrite files and possibly affect programs installed on your hard drive. Therefore, do not reinstall Windows XP unless a Dell technical support representative instructs you to do so.
-  **NOTICE:** To prevent conflicts with Windows XP, disable any virus protection software installed on your computer before you reinstall Windows XP. See the documentation that came with the software for instructions.

Booting From the Operating System CD

- 1 Save and close any open files and exit any open programs.
- 2 Insert the *Operating System* CD. Click **Exit** if the **Install Windows XP** message appears.
- 3 Restart the computer.

- 4 Press <F12> immediately after the DELL logo appears.
If the operating system logo appears, wait until you see the Windows desktop, and then shut down the computer and try again.
- 5 Press the arrow keys to select **CD-ROM**, and press <Enter>.
- 6 When the `Press any key to boot from CD` message appears, press any key.

Windows XP Setup

- 1 When the **Windows XP Setup** screen appears, press <Enter> to select **To set up Windows now**.
- 2 Read the information on the **Microsoft Windows Licensing Agreement** screen, and press <F8> to accept the license agreement.
- 3 If your computer already has Windows XP installed and you want to recover your current Windows XP data, type `r` to select the repair option, and remove the CD.
- 4 If you want to install a new copy of Windows XP, press <Esc> to select that option.
- 5 Press <Enter> to select the highlighted partition (recommended), and follow the instructions on the screen.

The **Windows XP Setup** screen appears, and the operating system begins to copy files and install the devices. The computer automatically restarts multiple times.



NOTE: The time required to complete the setup depends on the size of the hard drive and the speed of your computer.



NOTICE: Do not press any key when the following message appears: `Press any key to boot from the CD`.

- 6 When the **Regional and Language Options** screen appears, select the settings for your location and click **Next**.
- 7 Enter your name and organization (optional) in the **Personalize Your Software** screen, and click **Next**.
- 8 At the **Computer Name and Administrator Password** window, enter a name for your computer (or accept the one provided) and a password, and click **Next**.
- 9 If the **Modem Dialing Information** screen appears, enter the requested information and click **Next**.
- 10 Enter the date, time, and time zone in the **Date and Time Settings** window, and click **Next**.
- 11 If the **Networking Settings** screen appears, click **Typical** and click **Next**.
- 12 If you are reinstalling Windows XP Professional and you are prompted to provide further information regarding your network configuration, enter your selections. If you are unsure of your settings, accept the default selections.

Windows XP installs the operating system components and configures the computer. The computer automatically restarts.



NOTICE: Do not press any key when the following message appears: `Press any key to boot from the CD`.

- 13 When the **Welcome to Microsoft** screen appears, click **Next**.
- 14 When the **How will this computer connect to the Internet?** message appears, click **Skip**.
- 15 When the **Ready to register with Microsoft?** screen appears, select **No, not at this time** and click **Next**.
- 16 When the **Who will use this computer?** screen appears, you can enter up to five users.
- 17 Click **Next**.
- 18 Click **Finish** to complete the setup, and remove the CD.
- 19 Reinstall the appropriate drivers with the *Drivers and Utilities* CD.
- 20 Reinstall your virus protection software.
- 21 Reinstall your programs.

 **NOTE:** To reinstall and activate your Microsoft Office or Microsoft Works Suite programs, you need the Product Key number located on the back of the Microsoft Office or Microsoft Works Suite CD sleeve.

Using the Drivers and Utilities CD

To use the *Drivers and Utilities* CD (also known as the *ResourceCD*) while you are running the Windows operating system:

 **NOTE:** To access device drivers and user documentation, you must use the *Drivers and Utilities* CD while you are running Windows.

- 1 Turn on the computer and allow it to boot to the Windows desktop.
- 2 Insert the *Drivers and Utilities* CD into the CD drive.
If you are using the *Drivers and Utilities* CD for the first time on this computer, the **ResourceCD Installation** window opens to inform you that the *Drivers and Utilities* CD is about to begin installation.
- 3 Click **OK** to continue.
To complete the installation, respond to the prompts offered by the installation program.
- 4 Click **Next** at the **Welcome Dell System Owner** screen.
- 5 Select the appropriate **System Model**, **Operating System**, **Device Type**, and **Topic**.

Drivers for Your Computer

To display a list of device drivers for your computer:

- 1 Click **My Drivers** in the **Topic** drop-down menu.
The *Drivers and Utilities* CD (optional) scans your computer's hardware and operating system, and then a list of device drivers for your system configuration is displayed on the screen.
- 2 Click the appropriate driver and follow the instructions to download the driver to your computer.

To view all available drivers for your computer, click **Drivers** from the **Topic** drop-down menu.

Index

B

beep codes, 37

C

CDs

operating system, 6

conflicts

software and hardware
incompatibilities, 38

cover

removing, 19

D

Dell Diagnostics, 30

Dell support site, 7

diagnostics

beep codes, 37

Dell Diagnostics, 30

documentation

End User License
Agreement, 5

ergonomics, 5

online, 7

Product Information Guide, 5

regulatory, 5

safety, 5

User's Guide, 6

warranty, 5

drivers

list of, 42

Drivers and Utilities CD, 5

E

End User License
Agreement, 5

ergonomics information, 5

error messages

beep codes, 37

diagnostic lights, 34

system lights, 33

H

hardware

beep codes, 37

conflicts, 38

Dell Diagnostics, 30

Hardware Troubleshooter, 38

Help and Support Center, 7

help file

Windows Help and Support
Center, 7

I

installing parts

before you begin, 20

IRQ conflicts, 38

L

labels

Microsoft Windows, 6

Service Tag, 6

lights

diagnostic, 34

power, 17

system, 33

M

motherboard. *See* system
board

O

operating system

reinstalling, 6

reinstalling Windows XP, 39

Operating System CD, 6

P

power

light, 17

power light

diagnosing problems with, 33

problems. *See troubleshooting*

Product Information Guide, 5

R

regulatory information, 5
reinstalling
 Windows XP, 39

S

safety instructions, 5
Service Tag, 6
software
 conflicts, 38
support website, 7
system board, 25, 28
System Restore, 38

T

troubleshooting
 beep codes, 37
 conflicts, 38
 Dell Diagnostics, 30
 diagnostic lights, 34
 Hardware Troubleshooter, 38
 Help and Support Center, 7
 restore computer to previous
 operating state, 38
 system lights, 33

U

User's Guide, 6

W

warranty information, 5
Windows XP
 Hardware Troubleshooter, 38
 Help and Support Center, 7
 reinstalling, 6, 39
 setup, 41
 System Restore, 38